

45A 1 Gang DP Switch + Neon - Traditional Plate

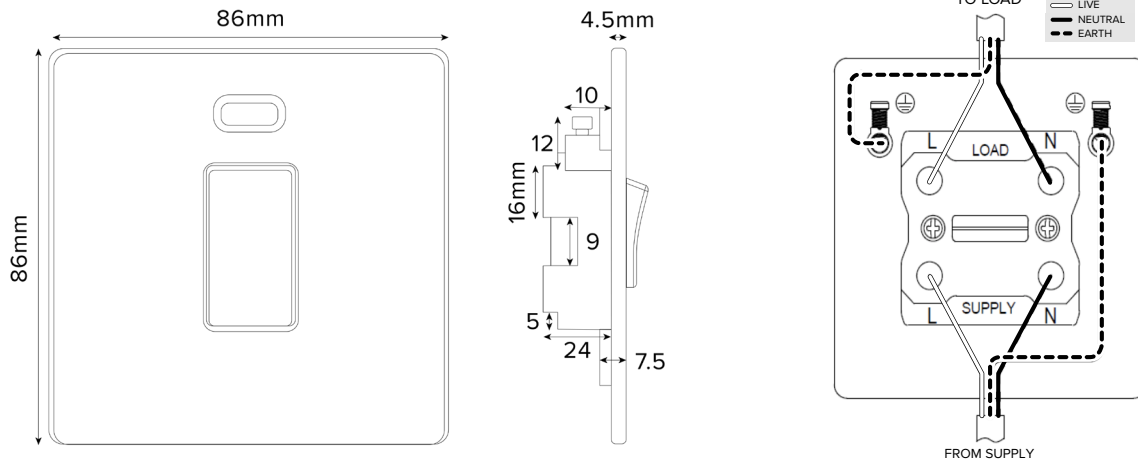

TECHNICAL SPECIFICATION

Standard(s)	BS EN 60669-1
Voltage Rating	45 Amp, 250V [~]
Contact Gap	Normal Gap
Mounting Box Depth (Min)	35mm
Terminal Capacity	4 x 4.0mm ² , 3 x 6.0mm ² , 1 x 16.0mm ² (L&N)
Earth Terminal Capacity	3 x 2.5mm ² , 2 x 4.0mm ² , 1 x 6.0mm ² (Earth)
Fixing Centres	60.3mm
Size	86mm x 86mm x 4.5mm (Plate thickness)
Product Class 1	Face plate must be earthed
Ambient Operating Temperature	-5° to +40°C
Recommended Location	Internal Use Only
Maximum Installation Altitude	2000m
IP Rating	IP2XD
Switched Poles	Double
Mains Frequency	50hz - 60hz
Contact Gap Minimum	3mm