

# 20-LTS301

## 20A 1 Gang 2 Way Toggle Switch - Traditional Plate

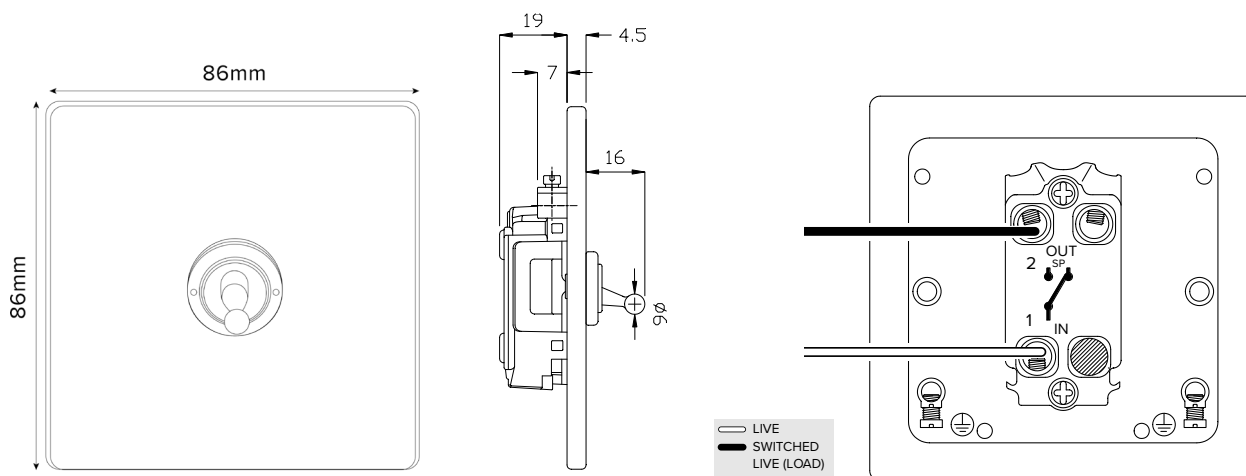

### TECHNICAL SPECIFICATION

Standard(s)	BS EN 60669-1
Voltage Rating	20 Amp, 250V <sup>~</sup> (20AX – no derating for inductive or fluorescent loads)
Contact Gap	Normal Gap
Mounting Box Depth (Min)	35mm
Terminal Capacity	3 x 2.5mm <sup>2</sup> , 2 x 4.0mm <sup>2</sup> , 1x 6.0mm <sup>2</sup>
Earth Terminal Capacity	3 x 2.5mm <sup>2</sup> , 2 x 4.0mm <sup>2</sup> , 1x 6.0mm <sup>2</sup>
Fixing Centres	60.3mm
Size	86mm x 86mm x 4.5mm (Plate thickness)
Product Class 1	Face plate must be earthed
Ambient Operating Temperature	-5° to +40°C
Recommended Location	Internal Use Only
Maximum Installation Altitude	2000m
IP Rating	IP2XD
Switched Poles	Single
Mains Frequency	50hz - 60hz
Contact Gap Minimum	3mm